

Varenummer: 03449150
 Beskrivelse: Fluro Heavy Duty Ledleje GE 150 SWE
 Hul Ø150
 Note: 150

Mål

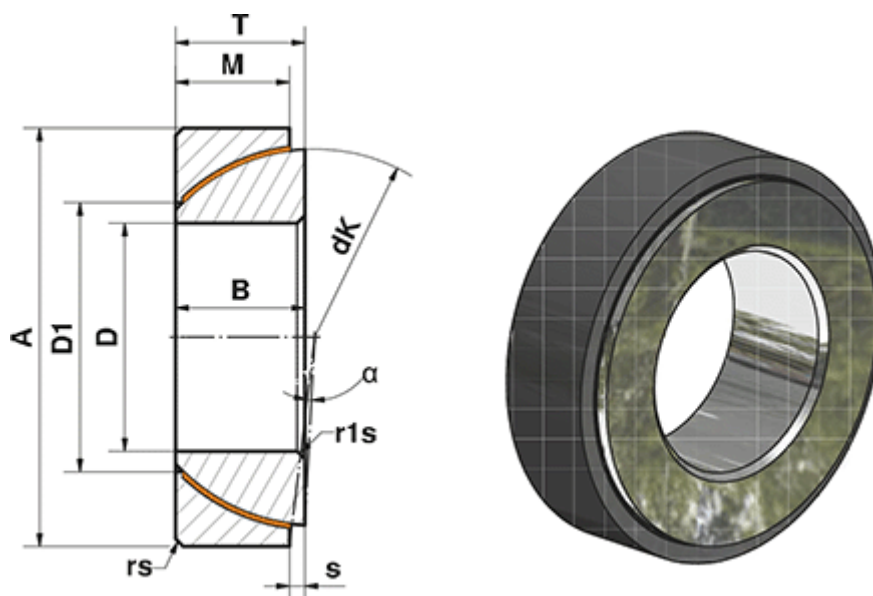

A	= 225	rs, r1s min	= 3
a (grader)	= 1	S	= 20
B	= 48	Statisk belastning C0 (kN)	= 3814
D	= 150	T	= 48
D1	= 171.4	Vægt (g)	= 8010
dK	= 211		
Dynamisk belastning C (kN)	= 2288		
M	= 46		